

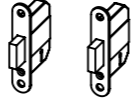

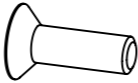



# SPARE PARTS GUIDE

ITEM NO.	DESCRIPTION	PART #	REFERENCE IMAGE
1	LOCK - PAIR OF 5-LEVER DEADLOCK, COMES WITH 6 KEYS	LOCK-DL2	
2	BOLT- M5X16 SOCKET COUNTERSUNK SCREW, ZINC PLATED (HIGH TENSILE GRADE 10.9)	BLT-M5X16-H	
3	SHELF - GALVANISED, COMES WITH 4 BRACKETS, FOR TSC2, FSC2, FC2	SHE-C2	
4	LIN BIN FOR FC RANGE 205X350X178	FCB	
5	CASTOR SET - 160mm BLACK WHEELS: 2X SWIVEL BRAKED, 2X FIXED; 4X CASTER PLATES, 16X M8 NYLOCS	CASS1	
5.1	CASTOR - 160MM BLACK RUBBER ON STEEL, SWIVEL BRAKED, 135KG CAPACITY	CAS160-SS-SB	
5.2	CASTOR - 160MM BLACK RUBBER ON STEEL, FIXED, 135KG CAPACITY	CAS160-SS-FX	
5.3	CASTOR - FIXING PLATE	CAS-CP	
5.4	FIXING KIT - COMES WITH 16X M8 NYLOCS	M8-NUT-KIT	

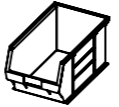
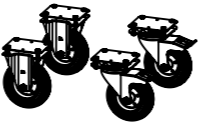

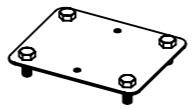
PRODUCT NAME:  
**FITTINGSTOR - FC2**

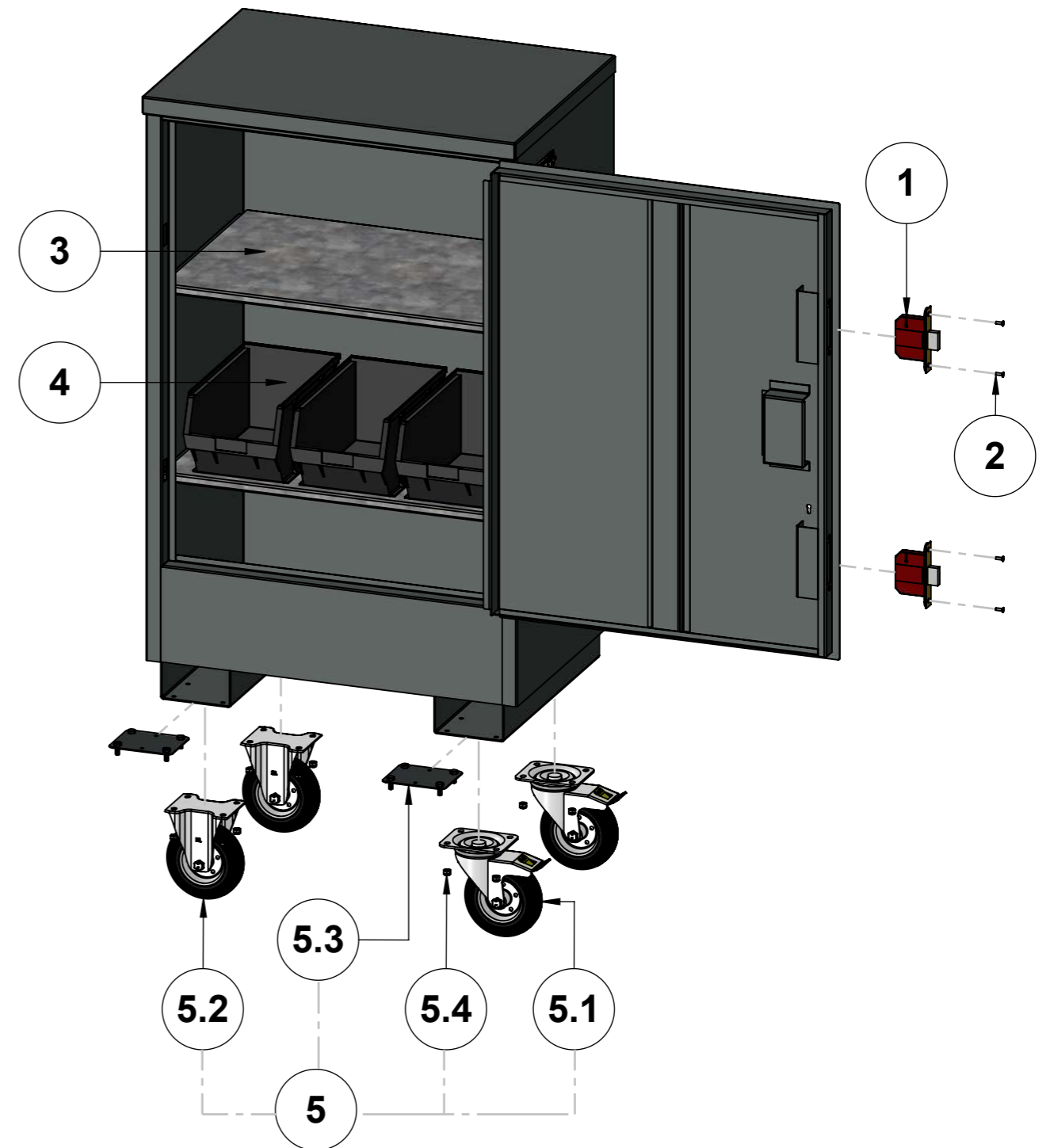
PRODUCT VERSION:  
P01

WEIGHT:  
97<sub>KG</sub>

NOTES:

LAST DATE SAVED:  
07/02/2025

THIS DRAWING MAY NOT BE COPIED, PUBLISHED OR TRANSMITTED TO A THIRD PARTY WITHOUT THE PRIOR WRITTEN CONSENT OF ARMORGARD LIMITED.

SPARE PARTS GUIDE

PRODUCT COLOUR:  
RAL7021 DARK GREY

LEAD TIMES MAY VARY – PLEASE ENQUIRE